

MS Series

Hot Melt Modular Guns



A universal value.

The new Valco Melton **MS Series** offers precise and flexible control for many applications, ensuring optimal uniformity and quality. The MS Series feature an industry standard compatible platform, easy to access heaters and RTD's, as well as multiple fluid port locations. All MS gun manifolds utilize high quality components and universal mounting brackets for easy configuration into any installation. The MS Series is available in both standard and washdown cordset options and are adaptable to any in-line filter assembly. The MS Series also uses an exclusive and unique single and multi-modular design, allowing for greater flexibility and faster delivery times.

Valco Melton's MS Series Offers:

- 100% *Compatible* spare parts
- High performance for optimal productivity levels
- Flexible production
- Durable design

Exclusive single modular and multi-modular profile

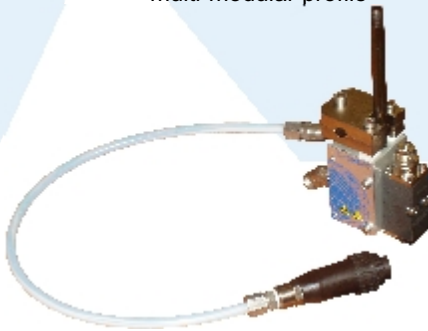

Old format option



SF Inline filters: straight, 45° and 90°

Pneumatic and mechanic opening and closing system

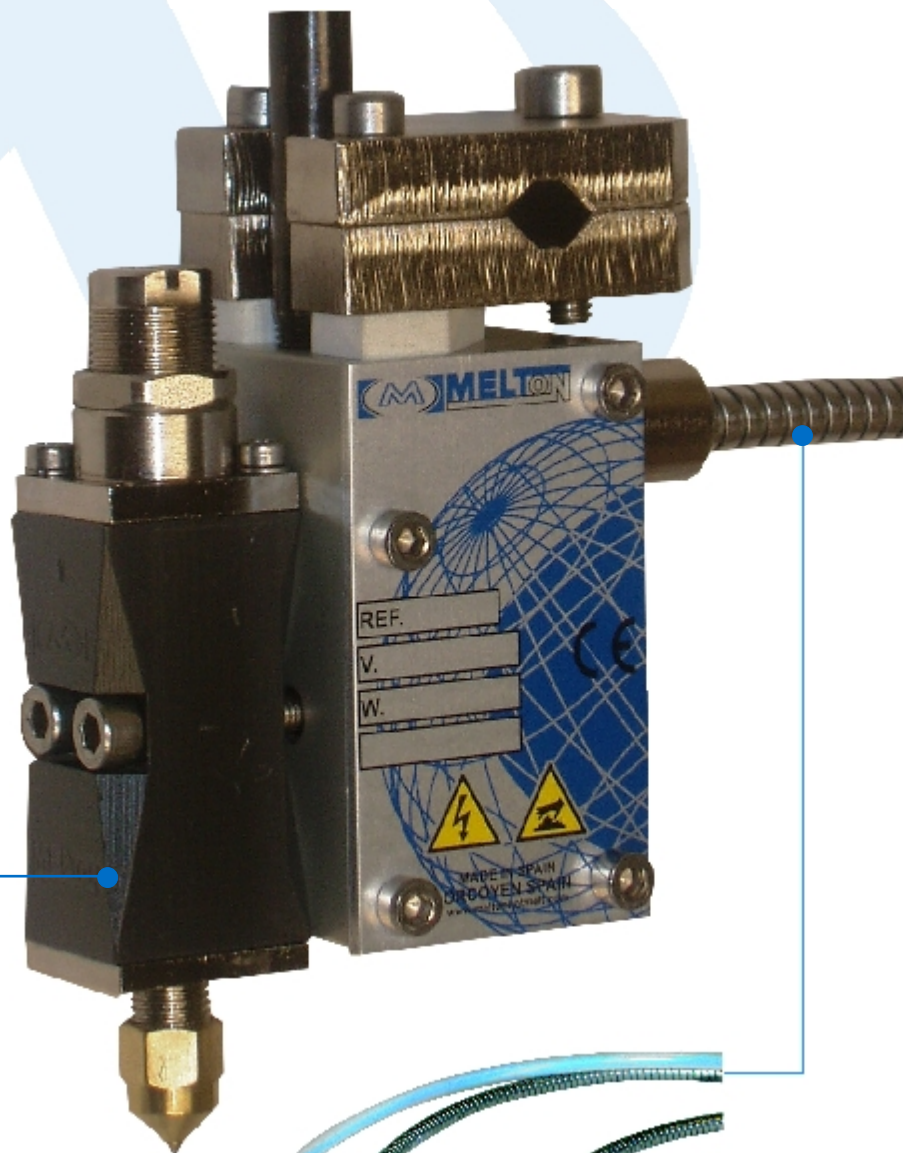

100% compatible connectors



MS Standard bead



MS CV0 y CVR



MS CH20 and High Flow



MS L20 and multi-line

- Valco Melton's **MS Series** guns are manufactured and tested for quality assurance, ensuring reliable and accurate adhesive application.
- 100% **Compatible** spare parts.
- Valco Melton offers a large variety of modules and nozzles to meet a diverse range of manufacturing needs.
- All Valco Melton products fulfill CE certification requirements.



Technical Characteristics	MS Series
Maximum Hydraulic Pressure	100 bar
Maximum Temperature	240°C
Temperature Sensor	Ni120, PT100, FEKO, NTC
Pneumatic Pressure	4 - 6 bar
Opening System	AOSC
Max Cycle Rate	2400 cycles/min

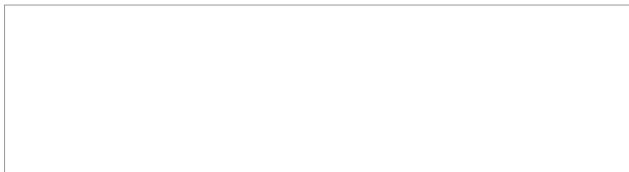
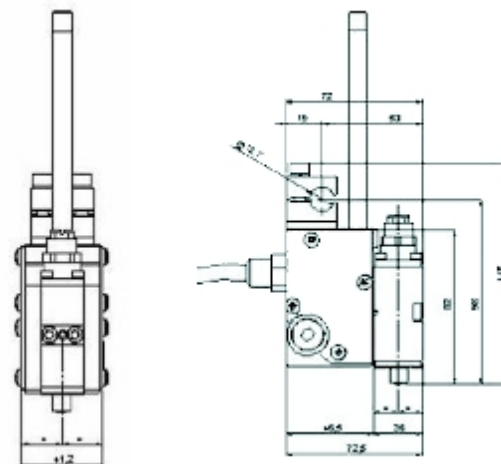

For more information visit www.valcomelton.com, or contact your local representative.
 World Headquarters: USA, Cincinnati, Ohio (Corporate Offices) • Tel: 513.874.6550 • Fax: 513.874.3612 • info@meltonhotmelt.com
 European Headquarters: Spain, Navarra • Tel: +34.948.321.580 • Fax: +34 948 326 584 • melton@melton.es
 Asian Headquarters: China, Xiamen, Fujian • Tel: +86.592.591.7854 • Fax: +86.592.591.7834 • china@valcomelton.com
www.valcomelton.com • Serving Over 70 Countries Worldwide.